

USER MANUAL



CAUTION

Changes or modifications not expressly approved by the party responsible for compliance could void the user's authority to operate the equipment.

This user manual includes detailed usage instructions for your product. Please read this manual thoroughly.

Figures and illustrations in this user manual are provided for reference only and may differ from actual equipment appearance.

Equipment design and specifications may be changed without notice.

Important Information	3
Important Safety Precautions	4
Vesa mount installation	6
Standard Accessories	7
Control Panel	8
Connection Panel	9
Remote Control	10
Connections	11
Basic Operations	12
Connection to wired internet	13
Basic Operations OTA update	14
Operating the navigation bar	15
Pre- installed apps	16
Display menu	17
System settings	20
Troubleshooting	23
Specifications	25

IMPORTANT INFORMATION

- If the unit is not positioned in a stable location, it can be potentially hazardous due to falling. Many injuries, particularly to children, can be avoided by taking simple precautions such as:
- Using cabinets or stands recommended by the manufacturer of the unit.
- Only use furniture that can safely support the unit.
- Ensure the CTOUCH interactive display is not hanging over the edge of the supporting furniture.
- Do not place the CTOUCH interactive display on tall furniture (for example, cupboards or bookcases) without anchoring both the furniture and the CTOUCH interactive display to a suitable support.
- Do not place cloth or other materials between the CTOUCH interactive display and supporting furniture.
- Do not let children climb on furniture to reach the CTOUCH interactive display or its controls.
- Do not use immediately after moving from a low temperature to high temperature environment, as this causes condensation, which may result in fire, electric shock or other hazards.
- To avoid possible condensation it is recommended to not use the device within 24 hours after its arrival.

Warning:

- To prevent the spread of fire, keep candles or other open flames away from the CTOUCH interactive display.

IMPORTANT SAFETY PRECAUTIONS

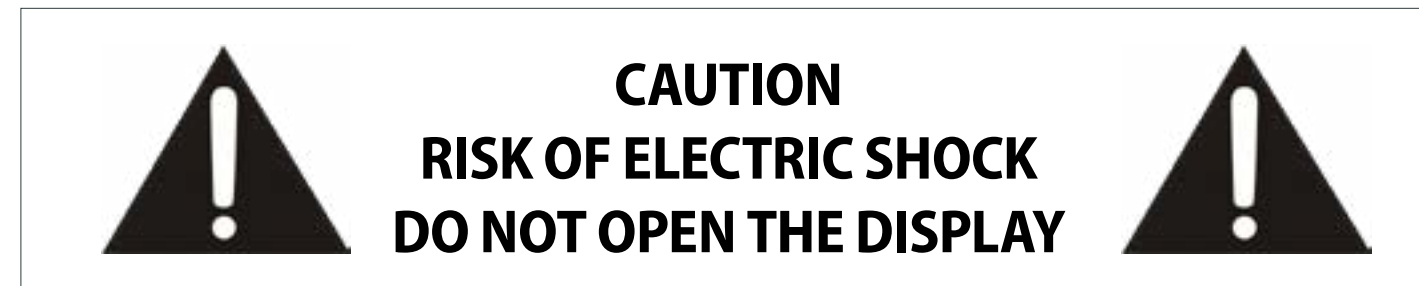

This symbol indicates dangerous voltage may pose a risk of electric shock for your CTOUCH interactive display. This label is located on the back of your CTOUCH interactive display.



This symbol indicates that important operating and maintenance instructions are contained in the literature accompanying your CTOUCH interactive display.

Electricity may cause personal injuries and property damage if handled improperly. The CTOUCH interactive display has been engineered and manufactured with the highest priority on safety. But IMPROPER USE CAN RESULT IN POTENTIAL ELECTRIC SHOCK OR FIRE HAZARD. In order to prevent potential danger, please observe the following instructions when installing, operating and cleaning the product. To ensure your safety and prolong the service life of your CTOUCH interactive display, please read the following precautions carefully before using the product.

1. **Read these instructions** - All operating instructions must be read and understood before the product is used.
2. **Keep these instructions** - These safety and operating instructions must be kept in a safe place for future reference.
3. **Note all warnings** - All warnings on the product and in the instruction manual must be observed closely.
4. **Follow all instructions** - All operating instructions must be followed.
5. **Attachments** - Only use attachments/accessories specified by the manufacturer. Do not use attachments which are not recommended by the manufacturer. Use of improper attachments can result in accidents.
6. **Power source** - This product is intended to be supplied with a listed power supply indicated on the marking label. If you are not sure of the type of power supply at your location, consult your product dealer or local power company. For added protection for this product during a lightning storm, or when it is left unattended and unused for a long period of time, unplug it from the wall outlet and disconnect the cable system.
7. **Power cord protection** - Protect the power cord from being walked on or pinched particularly at plugs, wall outlet, and the point where they exit from the device.

NOTE: Where the mains plug or an appliance coupler is used as the disconnected device, the disconnected device shall remain readily operable.

8. **Overloading** - Do not overload wall outlets, extension cords, or convenience receptacles on other equipment as this can result in a risk of fire or electric shock.
 9. **Entering of objects and liquids** - Never insert an object into the product through vents or openings. High voltages are present in the product and inserting an object can cause electric shock and/or short circuit internal parts. For the same reason, do not spill water or liquid on the product.
 10. **Servicing** - Refer all servicing to qualified service personnel. Servicing is required when the device has been damaged in any way, such as the power-supply cord or plug is damaged, liquid has been spilled, objects have fallen into the device, the device has been exposed to rain or moisture, does not operate normally or has been dropped.
 11. **Damage requiring service** - If any of the following conditions occurs, unplug the power cord from the AC outlet and request a qualified service technician to perform repairs.
 - a. When the power cord or plug is damaged.
 - b. When liquid is spilled on the product or when objects have fallen into the product.
 - c. When the product has been exposed to rain or water.
 - d. When the product does not operate properly as described in the operating instructions.
- Do not touch the controls other than those described in the operating instructions. Improper adjustment of controls not described in the instructions can cause damage, which often requires extensive adjustment work by a qualified technician.
- e. If the product has been dropped or the cabinet has been damaged in any way.
 - f. When the product displays an abnormal condition or exhibits a distinct change in performance. Any noticeable abnormality in the product indicates that the product needs servicing.
12. **Replacement parts** - In case the product needs replacement parts, make sure that the service person uses replacement parts specified by the manufacturer, or those with the same characteristics and performance as the original parts. Use of unauthorized parts can result in fire, electric shock and/or other danger.
 13. **Safety checks** - Upon completion of service or repair work, request the service technician to perform safety checks to ensure that the product is in proper operating condition.
 14. **Wall or ceiling mounting** - When mounting the device on a wall or ceiling, be sure to install the product according to the method recommended by the manufacturer. This is a safety issue.
 15. **Stand** - Use only with the trolley stand or wall mount specified by the manufacturer, or sold with the device. Do not place the product on an unstable trolley stand or wall mount. Placing the product on an unstable base can cause the product to fall, resulting in possible serious injuries as well as damage to the device. When mounting the product on a wall, be sure to follow the manufacturer's instructions. Use only the mounting hardware recommended by the manufacturer.
 - 15.1 Make sure you use all 4 bolts when placing a CTOUCH display on the Wallom2 lifts.

16. **Careful move** - When a trolley is used, be cautious when moving the trolley/device combination to avoid injury from the device tipping over. Sudden stops, excessive force and uneven floor surfaces can cause the product to fall from the trolley.
Careful move and be careful please, point of strength should not in display screen. Never attempt to move the CTOUCH interactive display unless the AC power cord has been disconnected.
17. **Do not use this device near water** - for example near a bathtub, washbowl, kitchen sink, laundry tub, in a wet basement or near a swimming pool. The device should not be exposed to dripping or splashing liquids and that no objects filled with liquids, such as vases, shall be placed on the device. Do not use immediately after moving from a low temperature to high temperature environment, as this causes condensation, which may result in fire, electric shock, or other hazards.
18. **Clean only with damp cloth** - Unplug the device from the power before cleaning. Do not use liquid cleaners or aerosol cleaners. Use a soft cloth for cleaning. Please contact your dealer for our cleaning material or look at support.ctouch.eu for our cleaning recommendations.
19. **Ventilation** - Do not block any ventilation openings. Install the CTOUCH interactive display in accordance with the manufacturer instructions. The vents and other openings in the cabinet are designed for ventilation. Do not cover or block these vents and openings since insufficient ventilation can cause overheating and/or shorten the life of the product. This product is not designed for built-in installation; therefore do not place the product in an enclosed space such as a bookcase or rack, unless proper ventilation is provided or the manufacturer's instructions are followed.
It should have interspace around the product and the wider it has the heat dissipation is better. Suggest up>10cm, around>10cm and back >2.5cm.
20. **Heat sources** - Do not install near any heat sources such as radiators, heat registers, stoves, or other device (including amplifiers) that produce heat.
21. **Panel protection** - The display panel used in this product is made of glass. Therefore, it can break when the product is dropped or impacted upon by other objects. Be careful not to be injured by broken glass pieces in case the display panel breaks.
Do not use hard or sharp object to take place of special pen when write in the screen.
Wipe the screen from one side to the other carefully till it looks completely clean.
Do not flailing in all directions.
22. **Pixel defect** - The display panel is a very high technology product, giving you fine detailed pictures. Occasionally, a few non-active pixels may appear on the screen as a fixed point of blue, green or red. Please note that this does not affect the performance of your product.

WARNING: For continued safety, device with class I construction shall be connected to a mains socket outlet with a protective earthing connection.

IMPORTANT SAFETY PRECAUTIONS

About Location / Environment

Do not use in hot and cold rooms (locations)

- When the unit is used in rooms (locations) with low temperature, the picture may leave trails or appear slightly delayed. This is not a malfunction. The unit will recover when the temperature returns to normal.
- Do not leave the unit in a hot or cold location. Also, do not leave the unit in a location exposed to direct sunlight to near a heater or in high humidity, as this may cause the cabinet to deform and the screen to malfunction and affect the CTOUCH interactive display's performance.
- Environment condition:
 - Operating temperature: 5°C – 35°C
 - Operating humidity: 20% – 80% (no moisture condensation)
 - Storage temperature: -15°C – 45°C
 - Storage humidity: 10% – 80%
 - Atmospheric pressure: 86 kPa ~106 kPa

About After-Image

The extended use of fixed image program material can cause a permanent after-image on the screen. This background image is viewable on normal programs in the form of a stationary fixed image. This type of irreversible screen deterioration can be limited by observing the following steps:

- A. Reduce the brightness/contrast setting to a minimum viewing level.
- B. Do not display the fixed image for extended periods of time.
- C. Turn the power off when the display is not in actual use.

Important Information Regarding Use of Video Games, Computers, Captions or Other Fixed Image Displays.

- Do not allow a still picture to be displayed for an extended period of time, as this can cause a permanent after-image to remain on the screen. Examples of still pictures include logos, video games, computer images, teletext and images displayed in 4:3 mode.

CAUTIONS:

- The permanent after-image on the screen resulting from fixed image use is not an operating defect and as such is not covered by the warranty.
- This product is not designed to display fixed images for extended periods of time.
- It is not advised to put the screen in portrait mode because this will affect the warranty.

Cleaning and Maintenance

To clean this unit, wipe with a soft, dry cloth.

Clean the cabinet with a soft, lint-free cloth. If the cabinet is especially dirty, moisten a soft, lint-free cloth in a weak detergent Solution, squeeze the excess moisture from the cloth, then wipe the cabinet with the cloth. Use a clean cloth to dry the cabinet.

- Use eyeglass cleaner to remove stubborn dirt from the screen.
- Never use alcohol, paint thinner or benzine to clean this device.

Carrying or Moving the CTOUCH interactive display

- When you move the CTOUCH interactive display, hold the frame of the CTOUCH interactive display .
- Be aware of the danger or harm which may be caused by carrying or moving the CTOUCH interactive display, as the bezel is very thin.
- When transporting, do not subject the unit to shocks or vibration, or excessive force.

Environmental Protection

The CTOUCH display should not be disposed of with household waste. Please recycle where facilities exist. Or contact CTOUCH to return your CTOUCH display free of charge.

VESA MOUNT INSTALLATION

1. Contact a professional for assistance when wall mounting the CTOUCH interactive display. We are not responsible for any damage to the product or injury to yourself, if you mount the CTOUCH interactive display on your own.
2. Do not wall mount the CTOUCH interactive display while the CTOUCH interactive display is turned on. It may cause personal injury due to electric shock.
3. Use standard M8 x 25 mm screws (4 pieces) to mount the CTOUCH interactive display.

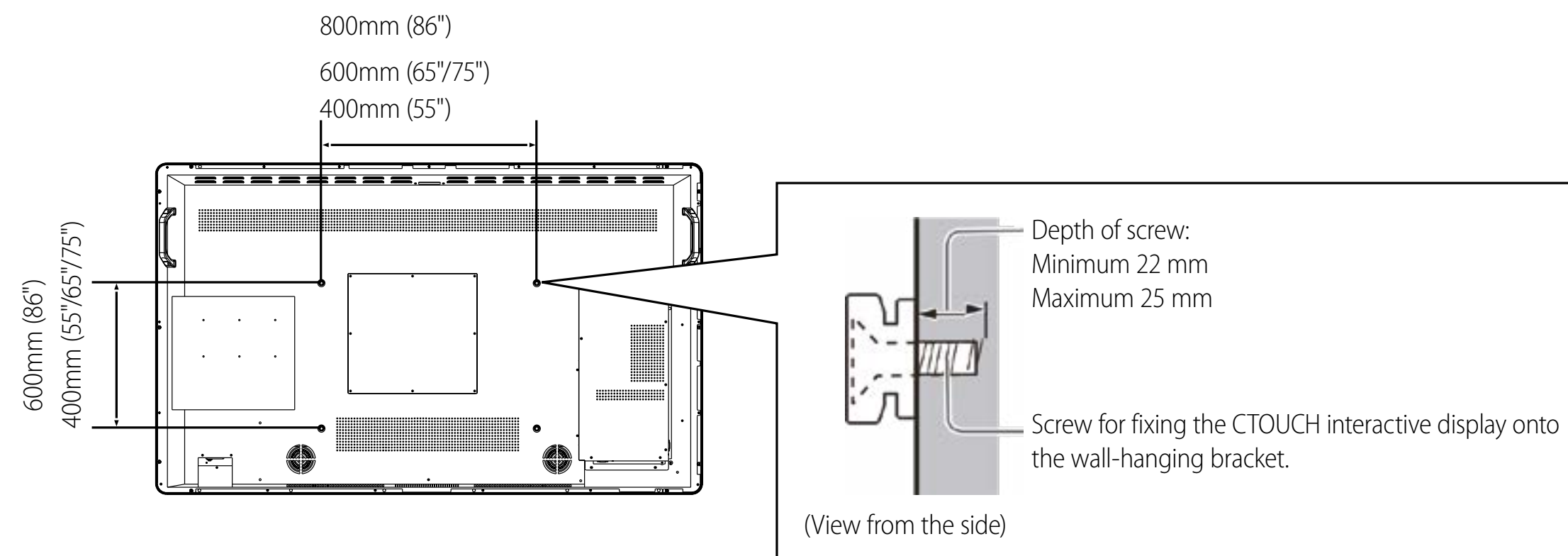

WARNING :

- Use only with the wall mount certified by GS.
- Always be sure to ask a qualified technician to carry out set up. Incorrect fitting may cause equipment to fall, resulting in injury and product damage. Any damage resulting from not having a professional installer mount your unit will void your warranty.
- When any optional accessories or wall hanging brackets are used, always ensure that the instructions provided are followed fully.
- Do not mount the unit directly below ceiling lights (such as spotlights or halogen lights) which typically give off lots of heat. Doing so may warp or damage plastic cabinet parts.
- Be careful when fixing the wall brackets to the wall. Always ensure that there are no electrical cables or pipes in the wall before hanging the bracket. Wall mounted equipment should not be grounded by metal within the wall.

STANDARD ACCESSORIES

Unpacking

The following items are included in your product box.

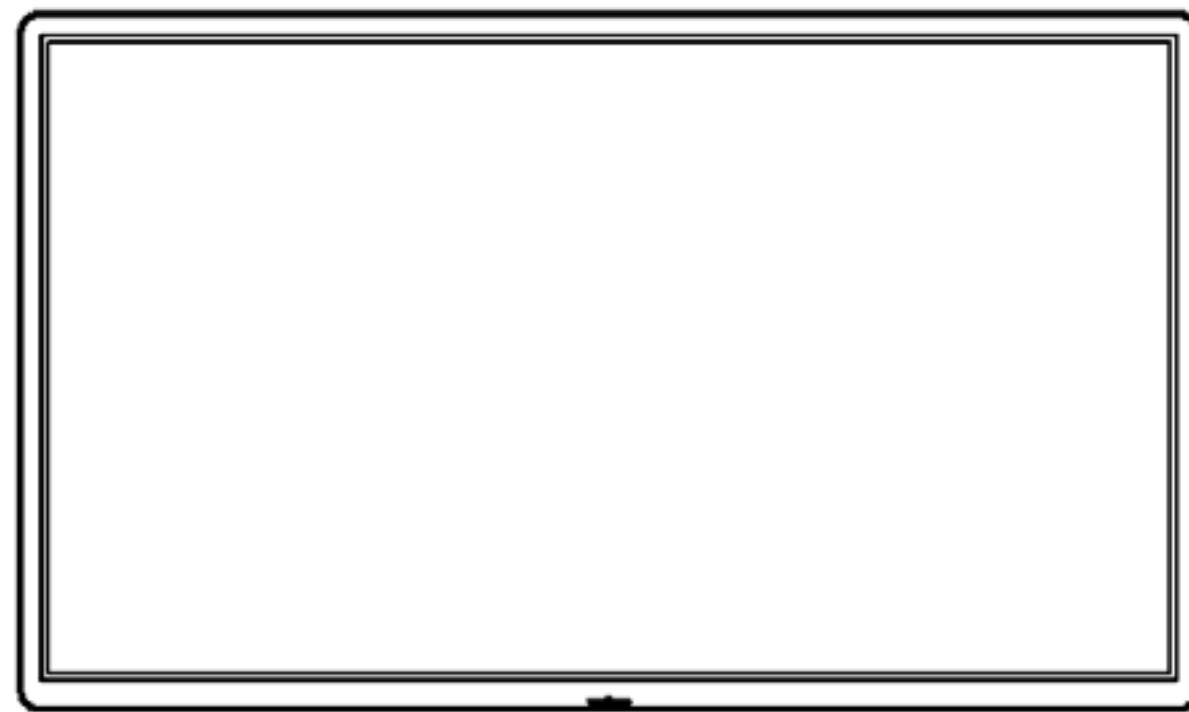

CTOUCH interactive display



Remote Control



Touch pen & Dynamic pen



AC Power Cord



UK AC Power Cord

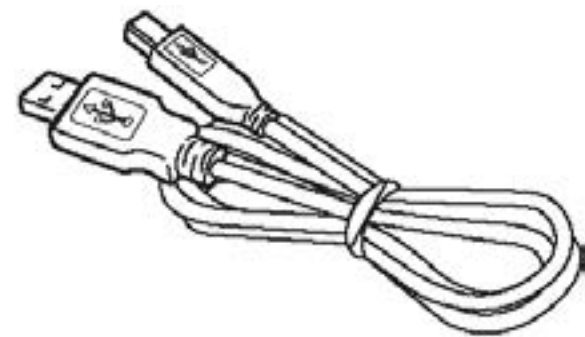

USB Cable



HDMI Cable

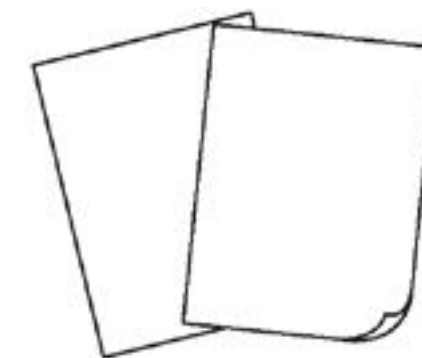

Quick Start Guide



Warranty Card

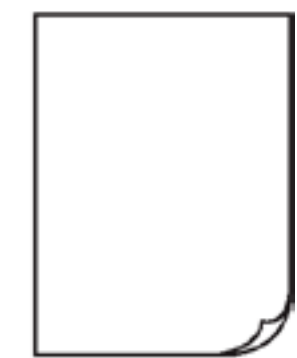

Welcome Letter

Notes:

The illustrations may differ slightly from the items shipped with your product.

CONTROL PANEL

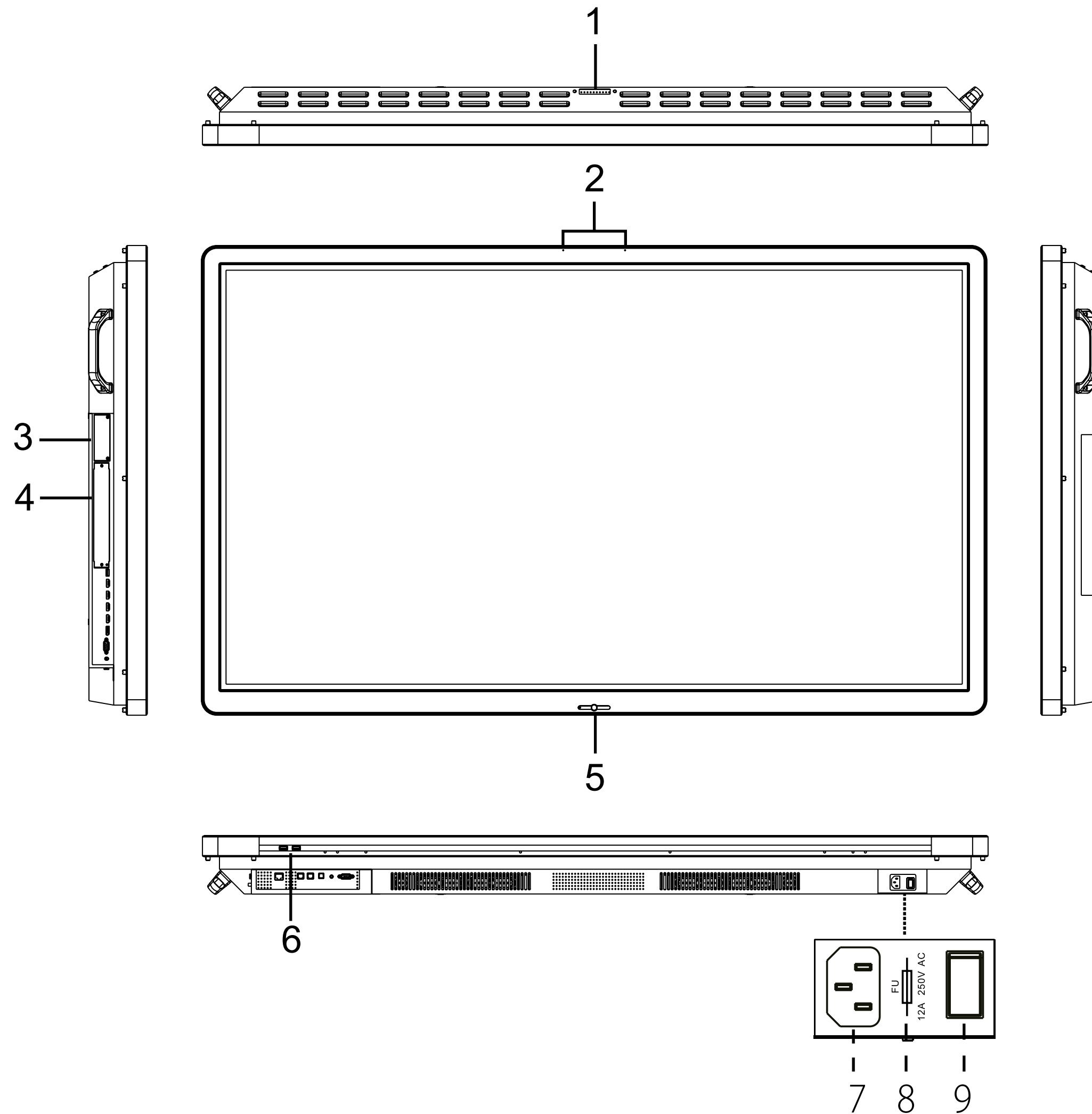

Nr.	Description
1	USB(2.0) (for camera) This port is for connecting a camera. Notes: Please open the dust cover before being used. It can perfectly support cameras up to 720p.
2	Microphone Voice input.
3	UP-Android Module Insert an UP-Android module.
4	OPS module slot Insert an OPS module (Optional).
5	Power LED Red: In standby mode. Blue: In power on mode.
CTOUCH Button	Remote control sensor Aim the remote control towards this spot on the CTOUCH interactive display.
	Power Press to switch the CTOUCH interactive display on or off. Note: When the CTOUCH interactive display is turned on, press the button in the middle to show the Float Bar. Press the button for about 2 seconds and the screen will go into stand-by mode.
6	USB Connect USB devices to this port for OPS and COS™.
7	AC IN Plug the AC cord into this jack and into a power outlet. (AC 100-240V 50/60Hz)
8	Fuse 12A 250V
9	Power Switch Push (I) to turn on the power, push (O) to cut off the power. Note: Don't cover the power switch.

CONNECTION PANEL

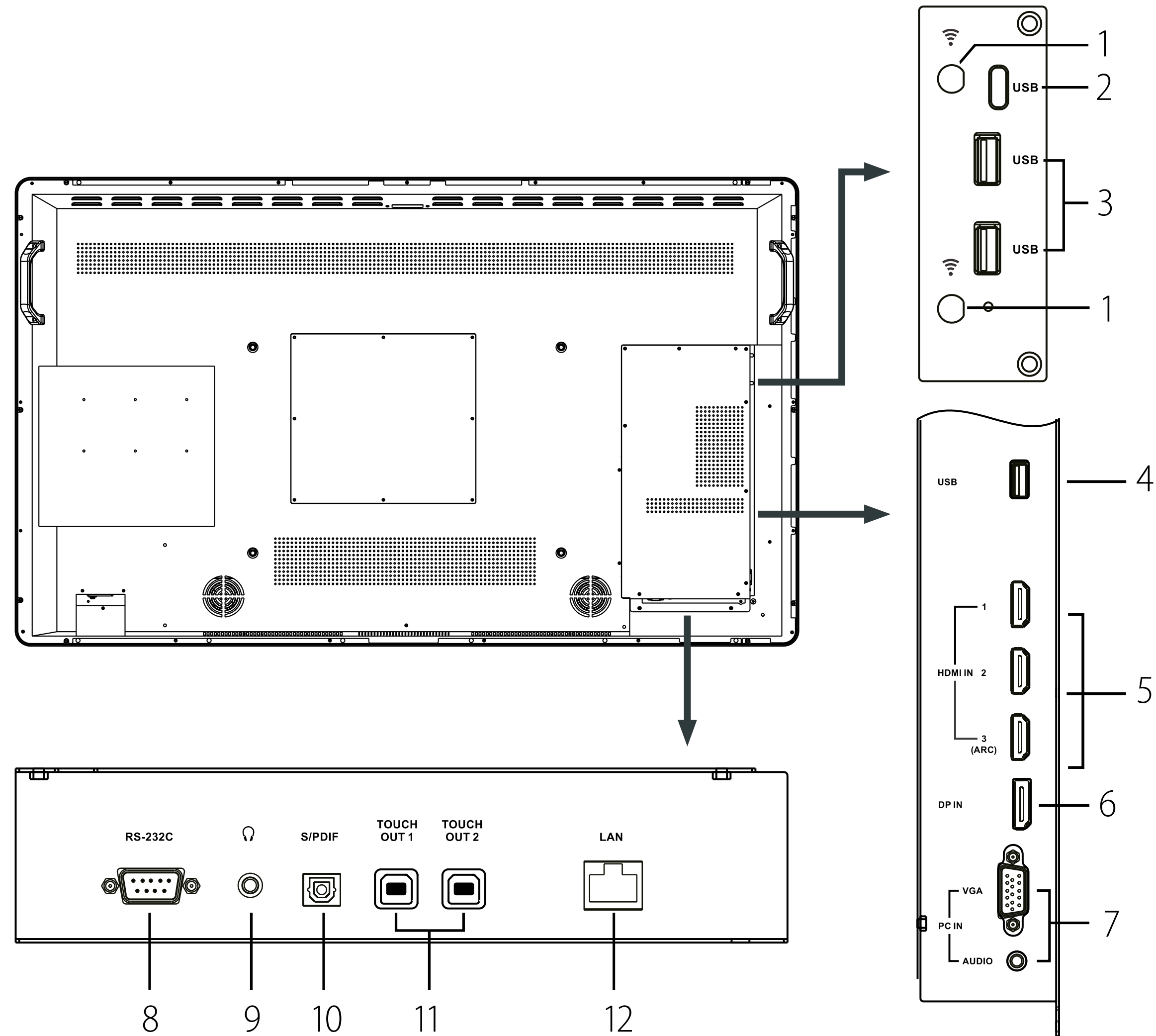

Nr.	Description
1	Antenna WiFi antenna. (Tighten the WiFi antenna in clockwise direction).
2	USB (Type-C) For data transmission on the Android.
3	USB Connect USB devices to these ports for Android.
4	USB Connect USB devices to this port for the OPS or Android. Note: use this USB-port for software updates.
5	HDMI1/2/3 IN Connect an HDMI or DVI device to this HDMI port. HDMI3(ARC): Connect an ARC-enabled home theater receiver to this HDMI port.
6	DP(DisplayPort) IN Connect a DP device to this DP port. Note: The current selected source is audible.
7	PC IN Connect the video/audio of a computer to these ports.
8	RS-232C For remote control, service and other uses.
9	 Connect headphones to this jack. The current selected source is audible.
10	SPDIF digital audio OUT Connect a digital sound system to this SPDIF jack.
11	TOUCH OUT 1/2 Output for external devices connected to PCx, HDMIx or DP ports, which support touch systems.
12	LAN Connects the external network or router.

Note: If the CTOUCH display is on the VGA source and does not get any signal, it will go into stand-by mode after two minutes.
When the CTOUCH display is on others sources and does not get any signal, it will go into stand-by mode after 10 minutes.

REMOTE CONTROL

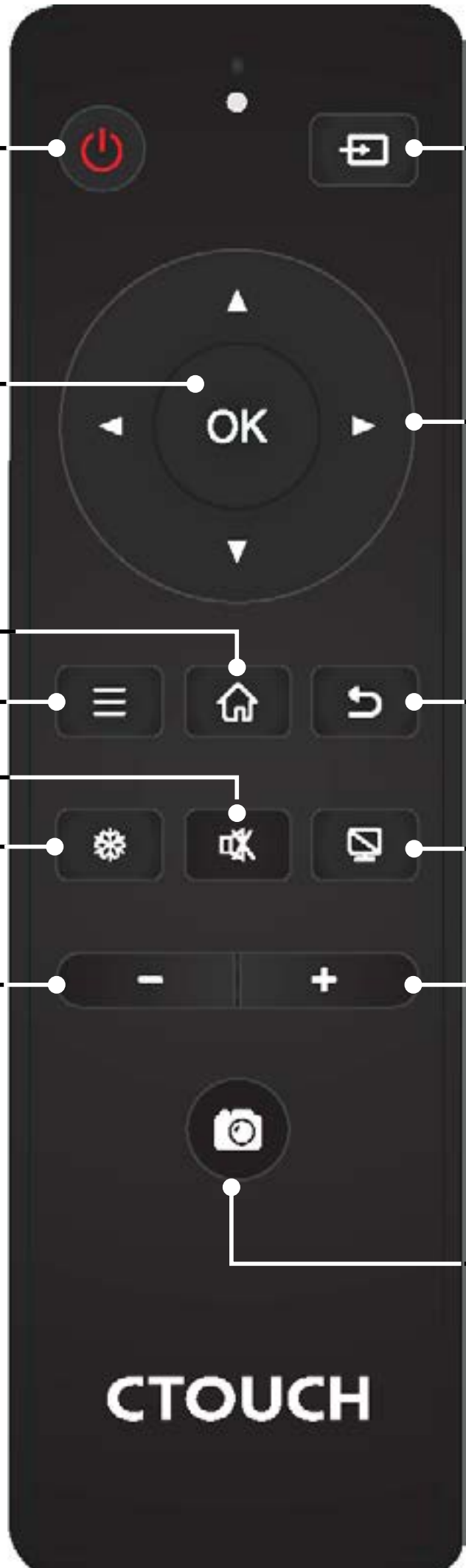

Switch the CTOUCH interactive display power on or off.

Confirm or enter a sub-menu or toggle between options during menu operation.

Display desktop (Home page) on the screen.

Display or exit the setting menu screen.

Mute the sound.

Freeze the current picture.

Volume down.

Display or exit input source menu.

Use the Arrow buttons to navigate in on-screen menu.

Return to previous menu or exit the on-screen menu.

Turn off the picture on the CTOUCH interactive display and listen to the program audio only.

Volume up.

Screenshot function
Please make sure to plug in a USB device into the display in order to save the screenshots. If you do not insert a USB device, your screenshot will be lost.

Note: If you want to make a screenshot without using a USB device, please use the screenshot function on the annotation tool in the Float Bar.

CONNECTIONS

Cautions Before Connecting

- When connecting an external device to the CTOUCH interactive display, make sure that the CTOUCH and the external device are turned off.
- Check the plugs at the ends of the cables to make sure that they are the correct type before plugging them into the jacks on the CTOUCH interactive display.
- Make sure that all plugs are securely inserted into the jacks. Loose connections can result in image or color problems.
- The illustration of the external device may be different depending on your model.
- Refer to the operating manual of the external device as well.

1. Connect the female plug to the AC socket on the unit.
2. Connect the male plug to the wall outlet as illustrated.

Notes:

- This product should be operated only from the type of power source indicated on the marking label.
- Always unplug the AC cord from power outlet when you won't use the screen for a long period of time.

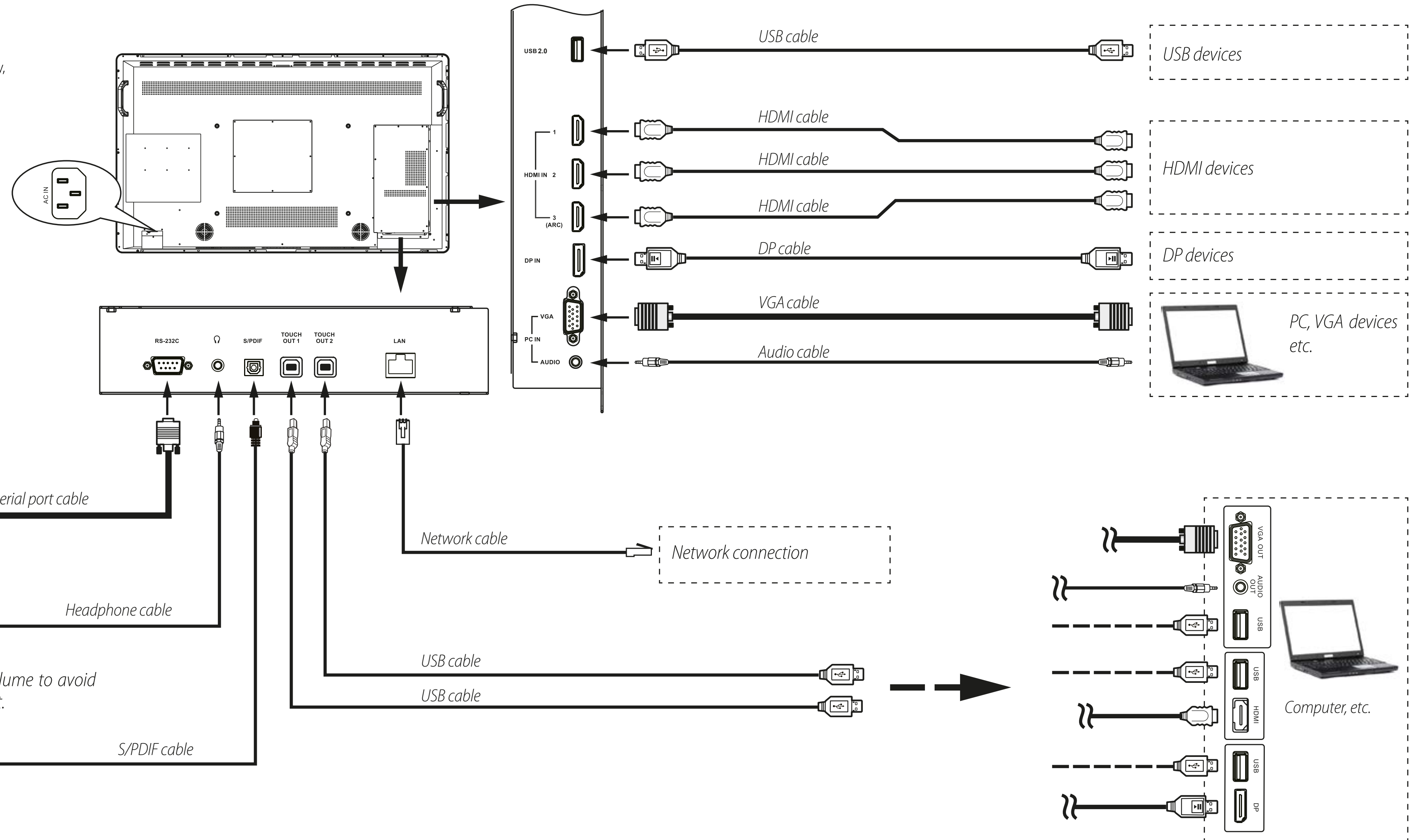

Computer, etc.



Audio input devices

Before using headphones, adjust the device volume to avoid excessive volume, as hearing damage may result.

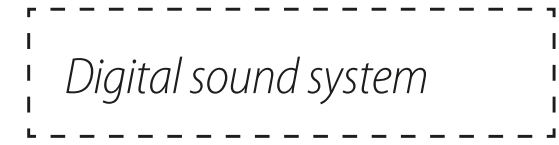

Digital sound system

BASIC OPERATIONS

TURNING THE CTOUCH INTERACTIVE DISPLAY ON OR OFF

1. Plug the power cord into an AC power outlet.
2. Switch the Power Switch on, to turn the CTOUCH interactive display on.
3. The display is in standby mode now. Wait a moment until the power indicator lights up, then press  to turn on the CTOUCH interactive display.

NOTE: Be sure to wait for a few seconds before pressing  button. If you promptly press  the CTOUCH interactive display may act wrongly or not respond at all.

4. Press  button again to put the display in standby mode.
5. Switch the Power Switch off to cut off the power completely.

FIRST TIME INSTALLATION

When turning on the CTOUCH display for the first time, the below shown installation menu pages will appear on the screen.

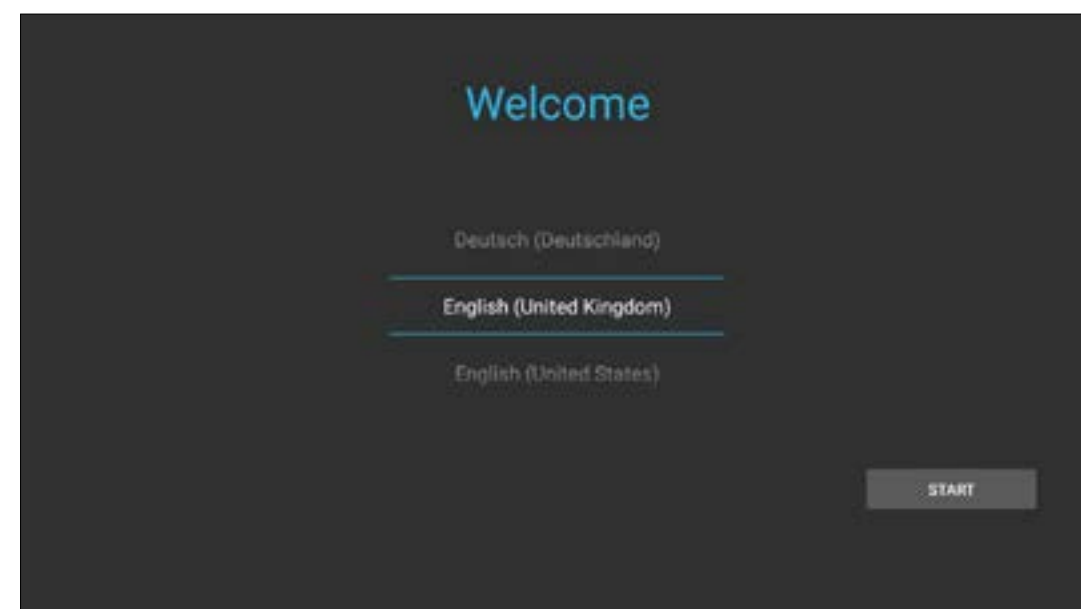

Select the desired menu language.
Press START to go to the next page.



Select your location and press NEXT
to go to the next page.



Select your required Energy Saving
Mode and press NEXT to finish the
installation.

CONNECTING TO WIRED INTERNET

Plug the LAN cable into the LAN port on the bottom of the CTOUCH display, to connect to the internet.

Connecting to wireless internet



1. Click on the Android Menu icon in the Float bar



2. Click on Wi-Fi

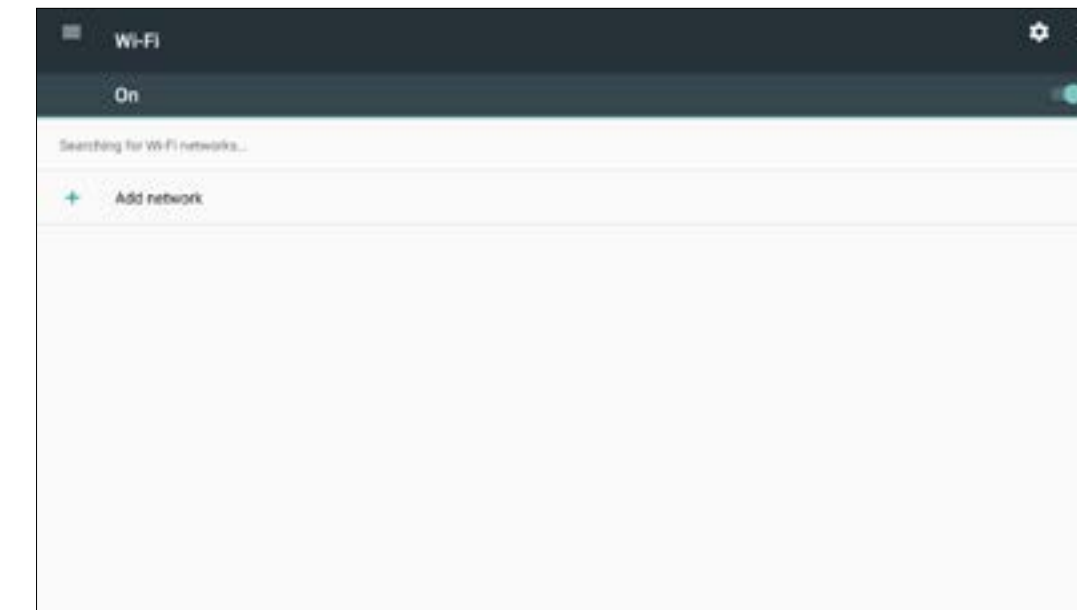

3. Turn the Wi-Fi on by touching the on/off button on the right upper side



4. Select the requested Wi-Fi network



5. Fill in the password and select 'connect'



6. The connection is set if you see 'connected' underneath the connected network

BASIC OPERATIONS

OTA UPDATE

When you connect your display to the internet, a notification will appear when a new firmware update is available. It may happen that two notifications will appear. One of the notifications is for the firmware update of the display. The other notification will be for the update of the UP-Android module. Please make sure you update both, in order to update the whole system.

Note: A LAN-connection is required to update the display via OTA. If you do not have a LAN-cable available, you can update the display by using a USB device. Please contact your dealer for the USB update method firmware file.

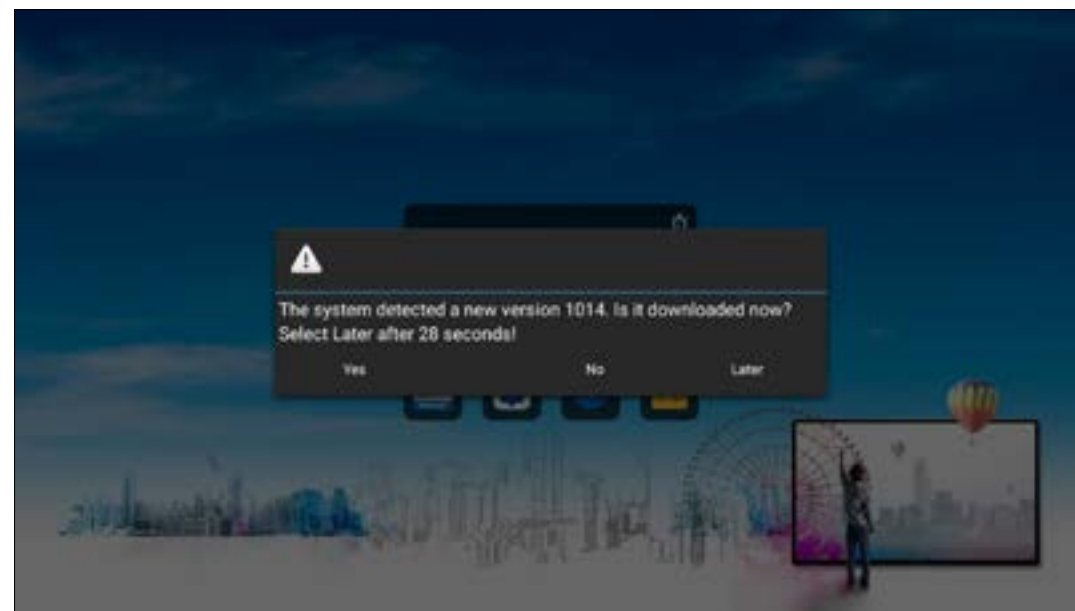

Select the option you would like.

Yes = See next photo.

No = The notification will not appear again until the next firmware update.

Later = The next time you turn on the display the notification will appear again.

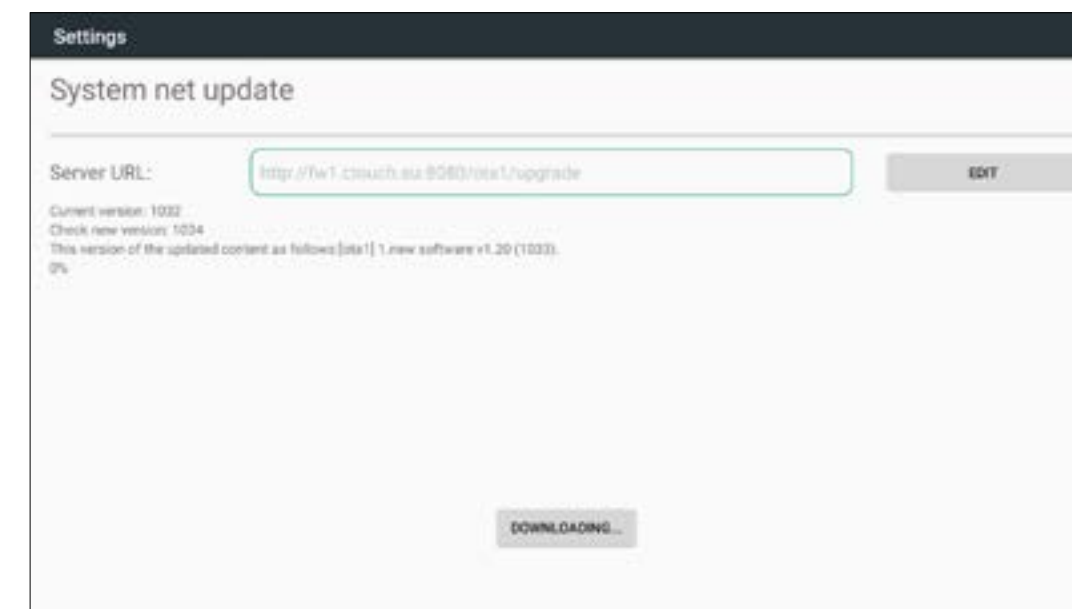

Click 'Download' to download the firmware update. After the download is complete, the installation will start automatically. This will take about 10 minutes.

OPERATING THE NAVIGATION BAR

Slide up from the bottom of the screen centre with two fingers to call the Navigation Bar

Note: It can happen that icons in the Float Bar are greyed out. This means that these functions are hidden/locked. There is nothing wrong with the display itself. If you want to get access to these functions, please contact your ICT contact person or dealer.

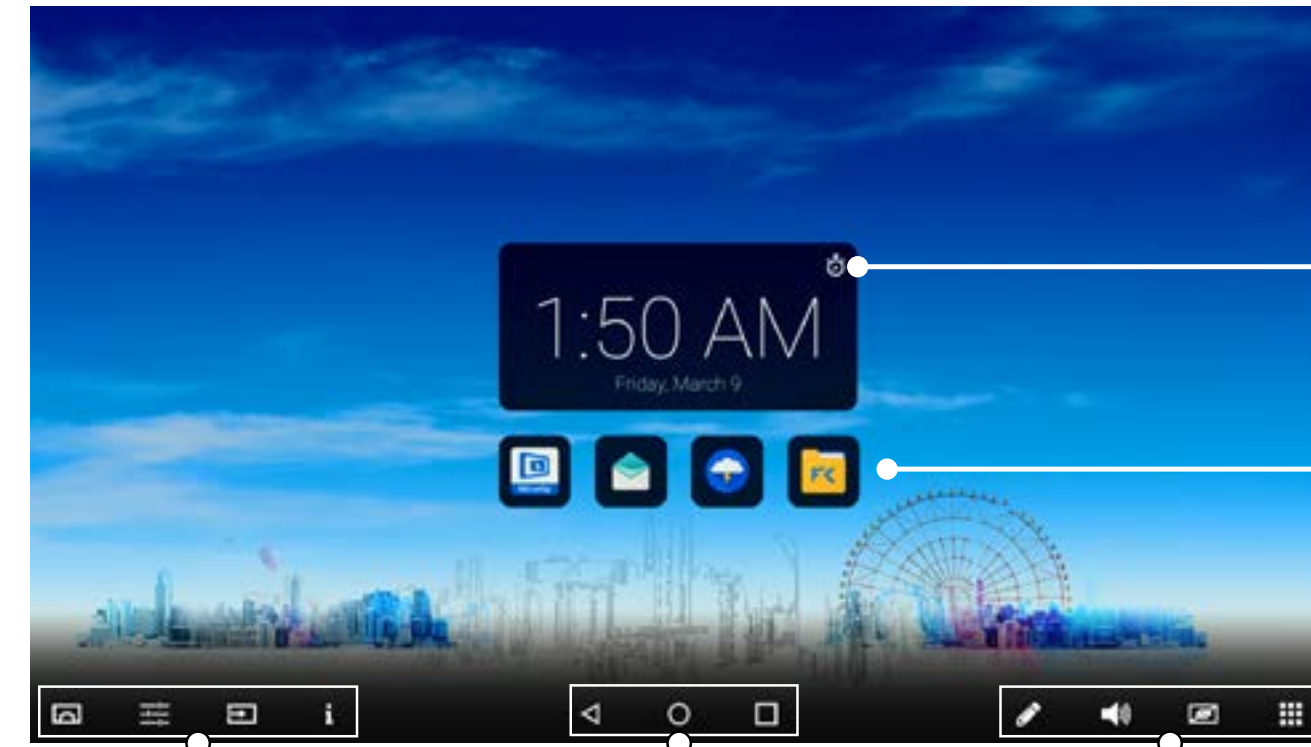

Setting the alarm clock

Shortcuts of favourite application



Display menu



COS™ menu



Source menu



User Manual



Previous screen



Home page



Application history



Annotation tool



Volume bar



Backlight mute function







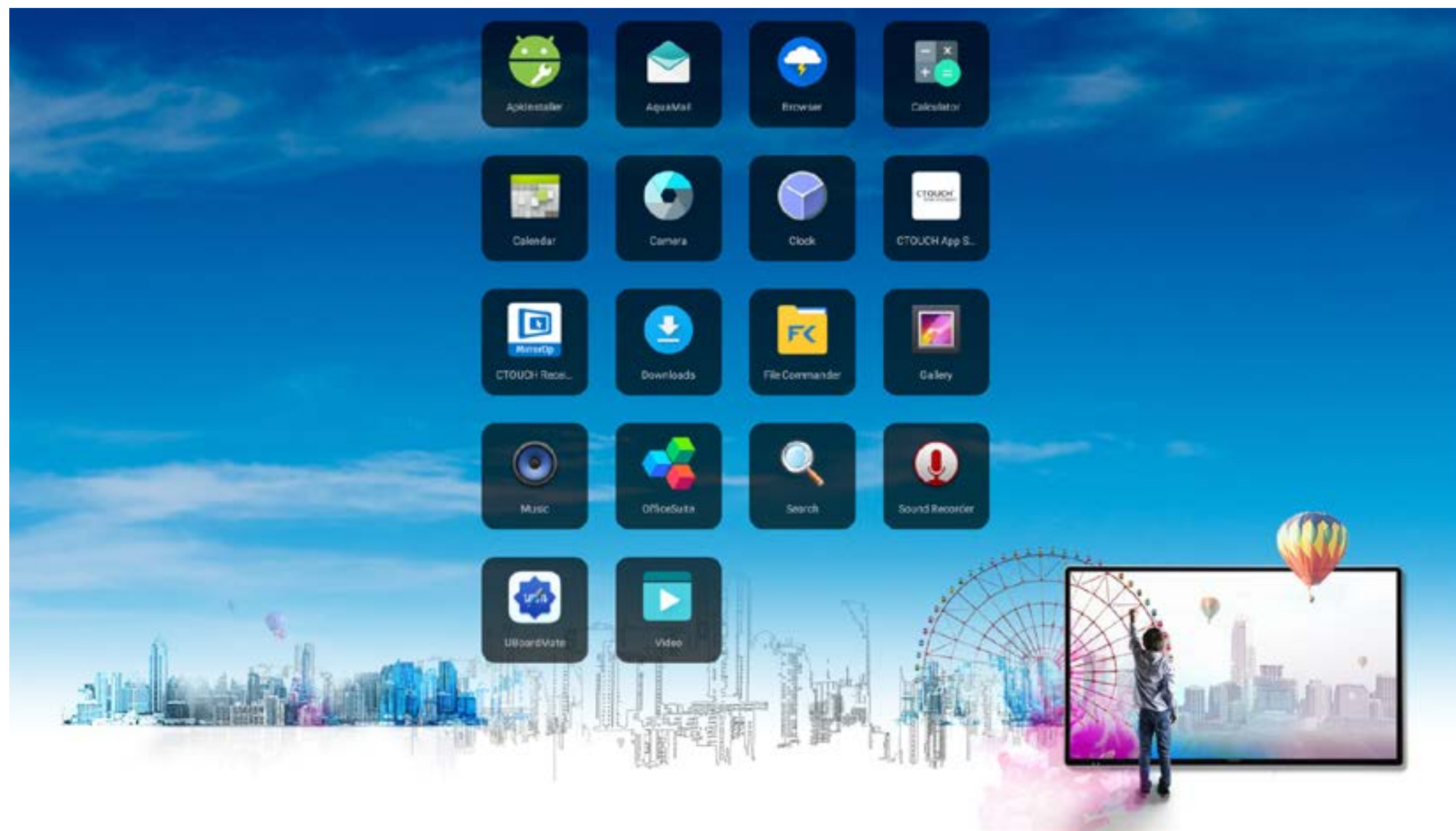













All Apps

PRE- INSTALLED APPS



From left to right:

-  **Apk Installer:** For installing third parties apps.
-  **Aqua Mail:** A mail client for using your email account on the display.
-  **Browser:** For surfing the internet.
-  **Calculator:** For performing calculations, ranging from basic arithmetic to complex mathematics.

-  **Calendar:** For organizing your activities. Note: the calendar of your email account can be automatically linked when setting up your email account in Aqua Mail.
-  **Camera:** For taking photos or making videos, if a camera is attached.
-  **Clock:** For setting an alarm, showing the time, using a timer and stopwatch
-  **CTOUCH App Store:** For searching and installing apps of your liking.
-  **MirrorOp:** For wireless content sharing.
-  **Downloads:** All downloaded content can be found here.
-  **File Commander:** For opening, editing, saving & sharing Word, PowerPoint, Excel and PDF files.*
-  **Gallery:** For viewing images from your display or USB device.*
-  **Music:** For playing music from your display or USB device.*
-  **Office Suite:** A file manager to view your files, copy and paste content from your USB to the display and the other way around, link your cloud accounts or connect to a FTP Server or network.
-  **Search:** Search content on the internet.
-  **Sound Recorder:** For voice recording.
-  **UBoardMate:** A versatile whiteboard application.
-  **Video:** For watching videos from your display or USB device.*

* for the best performance we advise you to place the content on the display first. For further explanation on how to use the pre-installed apps, please go to support.ctouch.eu.

DISPLAY MENU

Adjusting Picture mode



Picture	Picture Mode	Select picture mode
	Contrast	Adjust the contrast
	Brightness	Adjust the brightness
	Hue	Adjust the image hue (Only for NTSC system)
	Sharpness	Adjust the sharpness
	Saturation	Adjust the color saturation
VGA Screen Adjust	Backlight	Set up the overall brilliance of the screen
	Energy Save Mode	The backlight brightness is decreased
	Clock	Adjust the screen size
	Phase	Adjust the focus of stable images
	H-Position	Move the image right or left
V-Position	V-Position	Move the image up or down
	Auto Adjust	Automatically adjust the image settings such as position and phase
Blue Light Filter	Blue Light Filter	Set the blue light filter
	Color Temperature	Select the color temperature If you select User, you can set the level of the red/green/blue as your desired
Zoom Mode	Select the aspect ratio (display proportions) according to your video signal type or personal preference	
OverScan	Adjust the reproduction ratio, you may activate this function to obtain a cleaner picture	

DISPLAY MENU

Adjusting Sound mode



Sound	JBL Sound Mode	Select sound mode
	Bass	Adjust Bass (low sounds)
	Treble	Adjust Treble (high sounds)
	Balance	Adjust volume level of right and left speakers
	AVC	Select [On] to equalize overall volume levels across all channels Select [Off] to turn off the auto volume control
	JBL LiveStage	Turn the surround sound effect on or off
	SPDIF Output	Turn on or off
	SPDIF Mode	Select the digital audio output mode for S/PDIF Select [RAW] to output audio signal as its original format Select [PCM] to output audio signal by PCM format
	SPDIF Volume	Adjust SPDIF volume

DISPLAY MENU

Adjusting Setting menu



Setting	Source Auto Switch	Select On to automatically recognition source
	Auto Hide Float Bar	When this setting is On, if there is no operation in about 8 seconds, the float menu will disappear automatically.
	Color Range	Select color range (Only for HDMI mode)
	HDMI EDID Ver.	Select HDMI EDID Ver.
	HDMI_ARC	Select On to turn on enable HDMI_ARC
	Menu Timeout	Select OSD menu display time
	Off Timer	Set Off Timer to switch the CTOUCH to standby at a specified day and time
	On Timer	Set On Timer to turn on the CTOUCH automatically to source at a certain day and time
	Sleep Time	Set the duration of time until the monitor automatically goes into Standby mode [Off] / [10 Minutes] / [20 Minutes] / [30 Minutes] / [60 Minutes] / [90 Minutes] / [120 Minutes] / [180 Minutes] / [240 Minutes]
	Set Password	Password settings
	Change No Input Wallpaper	Set no input wallpaper
	Home Option	Set the behavior of Home button
Edit Input	Source	Select the input source you want to label
	Label	Edit the label of the selected input source
	Reset	Reset labels to defaults
	TouchOut1 To	TouchOut is there to define which touch signal output belongs to which input. E.g. if TouchOut1 is set to HDMI1 it means the touch signal output from TouchOut1 belongs to the input from HDMI1. When both ports are connected TouchOut2 has priority by default.
	TouchOut2 To	
	COS OTA Update	Update COS system by OTA.
	Set Display Menu to Default	Reset all Display Menu settings to factory defaults

SYSTEM SETTINGS

Set screen lock to protect your device

Set wallpaper

Select the Wireless Network you would like to connect with.

Bluetooth settings

Network settings reset & Ethernet

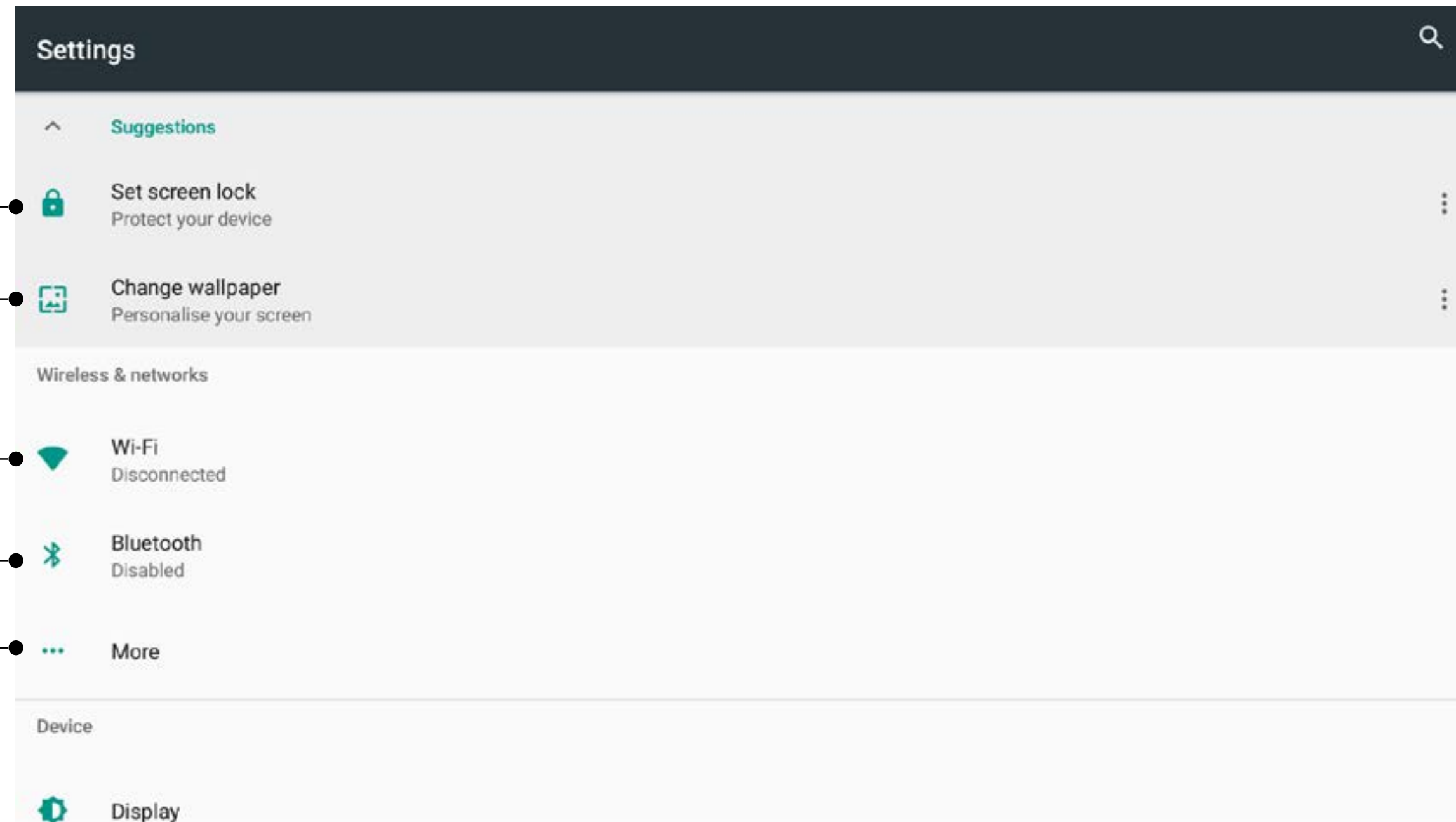

SYSTEM SETTINGS

The image shows a Windows Settings application window with a dark header bar labeled "Settings" and a search icon. Below the header, the "Device" category is selected. A list of settings is shown, with lines connecting them to external labels on the left:

- Screen display settings — Display (gear icon)
- All apps allowed to send — Notifications (bell icon, "All apps allowed to send")
- Sound settings — Sound (speaker icon)
- Show all apps — Apps (robot icon, "21 apps installed")
- Display system storage — Storage (three horizontal lines icon, "2.55 GB of 14.68 GB used")
- Display system memory — Memory (RAM icon, "Avg 552 MB of 1.9 GB memory used")
- Signed in as owner — Users (person icon, "Signed in as Owner")

SYSTEM SETTINGS

The image shows a screenshot of the Android Settings application. The interface is divided into two main sections: 'Personal' and 'System'. The 'Personal' section includes 'Security', 'Accounts', 'Languages & input', and 'Backup & reset'. The 'System' section includes 'Date & time' and 'About'. Lines connect external labels on the left to the corresponding settings items in the screenshot.

External Label	Internal Setting
Security and restrictions	Security
Manage accounts	Accounts
Android languages & Default input method	Languages & input
Reset all settings to factory defaults	Backup & reset
Date and time	Date & time
Android system information	About

TROUBLESHOOTING

For contact information and full warranty conditions refer to support.ctouch.eu. If, after reading these operating instructions, you have additional questions related to the use of your CTOUCH interactive display, please check the symptoms below and follow the suggested solutions. If you still have further questions, please visit support.ctouch.eu or call the services center in your local area.

Remote Control

Problem	Possible Solutions
Remote control does not operate	<ul style="list-style-type: none"> • Make sure the CTOUCH interactive display is switched on. • Check the direction of the batteries. • The batteries could be low. Replace the batteries.

Video and Audio

Problem	Possible Solutions
No picture (screen not lit) and no sound	<ul style="list-style-type: none"> • Make sure the power cord is plugged in. • Press POWER on the CTOUCH interactive display or on the remote control. • Test another source.
Dark, poor or no picture (screen lit) but good sound	<ul style="list-style-type: none"> • Select a proper picture mode. • Adjust the brightness in the video setting. • Test another source.
No colour, dark picture or abnormal colour	<ul style="list-style-type: none"> • Adjust the colour saturation in the video setting.
Good picture but no sound	<ul style="list-style-type: none"> • The sound may be muted. Press MUTE again to cancel. • Verify if sound should output and/or test another source.
Audio noise	<ul style="list-style-type: none"> • Communication problems may occur if infrared communication equipment (e.g., infrared cordless headphones) is used near the CTOUCH interactive display. Move the infrared communication equipment away from the CTOUCH until the noise is eliminated.

TROUBLESHOOTING

General

Problem	Possible Solutions
Some items cannot be accessed	<ul style="list-style-type: none"> If a setting option appears in grey, this indicates that the settings option is unavailable in current input mode. Some display menu items may be different when the unit works in different sources.
Remote control command is not working in some cases	<ul style="list-style-type: none"> During the timing of USB device detection (i.e. when the CTOUCH interactive display is turned on with USB device connected, or when you plug in USB device during the working of the CTOUCH), the display may not react on remote control buttons in such case. Wait a moment before the remote control should function again.
Control buttons do not operate	<ul style="list-style-type: none"> Disconnect the power cord and wait for a few seconds. Then re-plug the power cord and turn on the unit again
Touch does not work	<ul style="list-style-type: none"> If you use a Apple-device, please download the Mac-driver from our website.
Fog appear on the screen	<ul style="list-style-type: none"> For the safety of screens, adding stalinite out of the screens. It is need to keep certain space between two layers for reserving air passages generate cross-ventilation and for insuring heat dissipation. Fog mainly comes from the temperature difference between the screen and the external. Moisture streaks congeal when hot air meets the low temperature glass surface The fog does not impact the normal use and it disappears after several-hour usage.
Screen puts itself in stand-by mode as external device or Easy Air PC goes in sleeping mode.	<ul style="list-style-type: none"> Change the energy settings/sleeping-mode of the external device or Easy Air PC.

Note: If your problem is not solved, turn off your unit and then on again.

Cautions: Never attempt to repair a defective CTOUCH interactive display yourself.

SPECIFICATIONS

Model No.	CLN-65UHDA7	CLN-75UHDA7	CLN-86UHDA7
Visible screen size	65" (diagonal)	75" (diagonal)	86" (diagonal)
Power Source	AC 100-240V, 50/60Hz		
Current Max.	1.7 A	2.8 A	3.6 A
Power Consumption	93 W	150 W	189 W
Standby condition *	≤ 0.5 W	≤ 0.5 W	≤ 0.5 W
Number of pixels (Display panel)	3840 x 2160	3840 x 2160	3840 x 2160
Dimensions (W×D×H) (Unit: mm)	1524.2 x 113 x 911.6	1745 x 113 x 1036	1990.4 x 113 x 1173
Weight	55 kg	67 kg	100 kg
Operating conditions	Operating temperature: 5°C - 35°C, Storage temperature: -15°C - 45°C, Storage humidity: 10% - 80% Operating humidity: 20 % - 80 % (no moisture condensation), Atmospheric pressure: 86kPa ~ 106kPa		

Notes:

1. Design and specifications are subject to change without notice.
 2. Weight and dimensions shown are approximate.
 3. Specifications and external appearance may be changed for the sake of improvement.
- * Due to different standby conditions, the standby power consumption of some models could be higher than 0.5W.

Connection terminals of the CTOUCH interactive display

PC IN	1	Earphone	1
HDMI Input	3	S/PDIF OUT	1
DP Input	1	Touch OUT	2
USB	7	RS-232C	1
LAN	1		